

# APG® CASH DRAWER SERIES 4000 CASH DRAWER OPERATING & MAINTENANCE INSTRUCTIONS

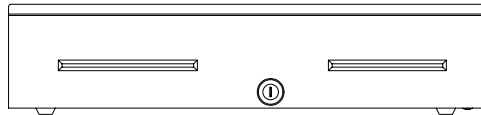

## GETTING STARTED

Prepare a location for the cash drawer. Recommendations for a suitable location include:

- A sturdy, level surface no less than the size of the cash drawer;
- Operating temperature from 20° F to 100° F (-7° C to 37° C);
- Non-condensing relative humidity from 20% to 80%.

## LOCK FUNCTIONS (If applicable)

Two keys are included with each cash drawer for the manual lock. The key lock provides four functions: locked open, manual open, electrically on-line, and locked closed. See Figure 2. The key may be removed in the 12 o'clock (Electrically On-Line), 9 o'clock (Locked Closed), or 3 o'clock (Locked Open) positions. To reduce the risk of damaging or breaking the key, remove the key from the lock during normal operation.

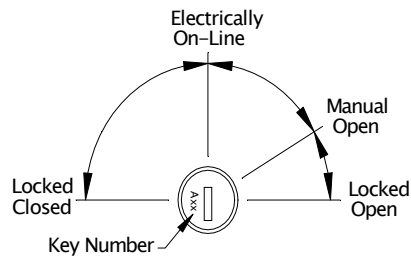

Figure 2

## MEDIA STORAGE

The media storage area, located below the till, includes two media trays with packaged bill dividers. The dividers may be re-positioned into the tray's grooves to better meet your needs.

## PARTS AND ACCESSORIES

For cash drawer parts and accessories, contact your supplier or visit our website at <http://www.apgcd.com>.

## REMOVING THE INNER DRAWER: PRODUCT STARTING WITH JB\*\* OR JD\*\*

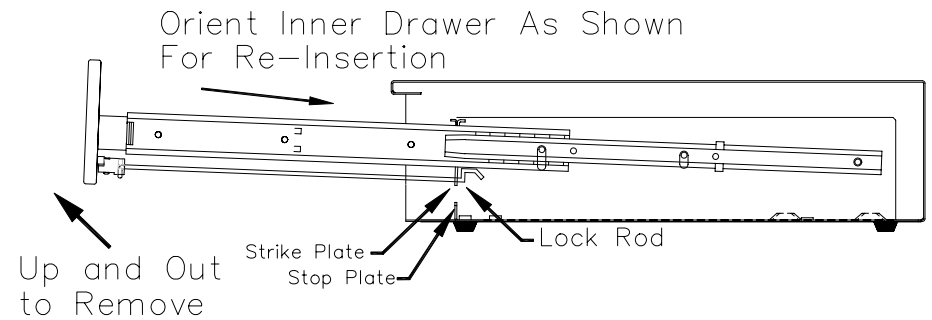

Figure 3

## REPLACING THE INNER DRAWER

Mate the outer slides (mounted to the drawer) with the inner slides (mounted in the cash drawer housing). Lift the drawer up until it stops, and begin to push the drawer into the cash drawer housing. When the strike plate on the back of the drawer has cleared the stop plate in the base, let the drawer rest in the horizontal position. Push the inner drawer to the fully closed position. You should experience additional resistance as you close the drawer since the ball bearings do not roll until the slides are fully engaged. When the inner drawer is fully inserted, cycle it a few times to verify that the drawer opens and closes properly.

## PREVENTATIVE MAINTENANCE

The cash drawer slides should be periodically cleaned and lubricated. Frequency is dependent on use and the environment. Using a dry, lint free cloth, wipe out the old grease and debris from the inner and outer slides. **Do not use water or any type of liquid cleaner.** Using a clean applicator, apply a thin layer of lithium-based bearing grease to the inner and outer slides. Cycle the slides several times to properly coat the ball bearings and to spread the grease evenly.

**CAUTION:** Breaking coin rolls on the money till may cause the plastic to fracture.



# ACCESSORIES

**PK-15TA-03-BX**  
**COIN ROLL STORAGE TILL**  
 15 5/16" x 11 1/8" x 2 5/16"

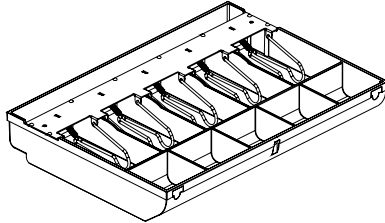

**PK-14L-03-R-BX**  
**LOCKING TILL COVER**  
 for PK-15TA-03 till kit only

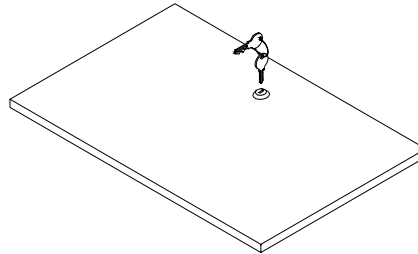

**PK-14R-03-BX**  
**RECESSED LOCKING TILL LID**  
 for PK-15TA-03 till kit only

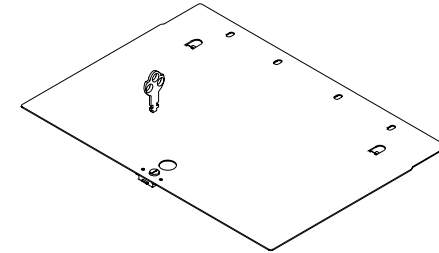

**PK-15U-5-BX TILL**  
**ADJUSTABLE 5 BILL 5 COIN TILL**  
 15 1/4" x 11 1/16" x 2 7/16"

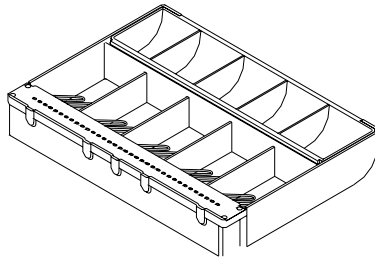

**PK-15U-6CCCL-BX TILL**  
**ADJUSTABLE 4 BILL 8 COIN TILL**  
 15 1/4" x 11 1/16" x 2 7/16"

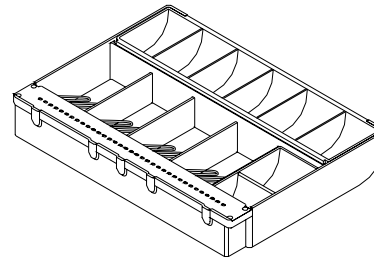

**PK-15U-6-BX TILL**  
**ADJUSTABLE 5 BILL 6 COIN TILL**  
 15 1/4" x 11 1/16" x 2 7/16"

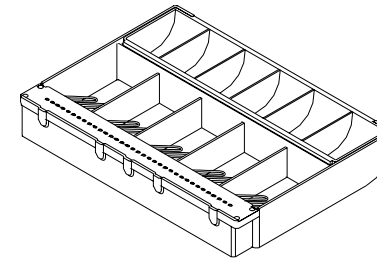

**PK-15VTA-BX TILL**  
**FIXED 5 BILL 5 COIN TILL**  
 15 5/16" x 11 1/8" x 2 5/16"

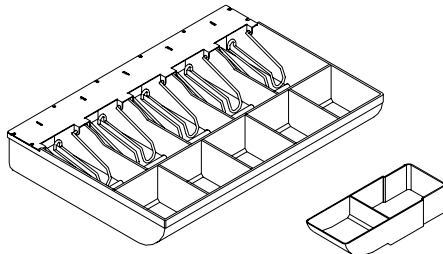

**PK-15J**  
**COIN CUP**  
 for PK-15VTA only

**PK-14L-R-BX**  
**LOCKING TILL COVER**  
 for PK-15VTA or PK-15U-\*\*\* till kits

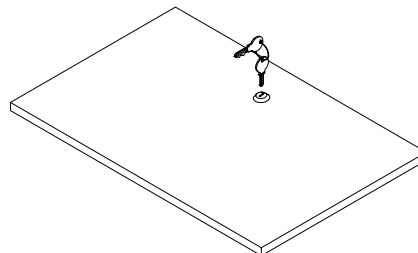

**PK-27-D-BX**  
**UNDER COUNTER MOUNTING**  
**BRACKET KIT**

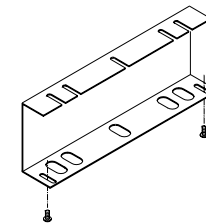

Kit includes two brackets, cash drawer mounting hardware and installation template.